

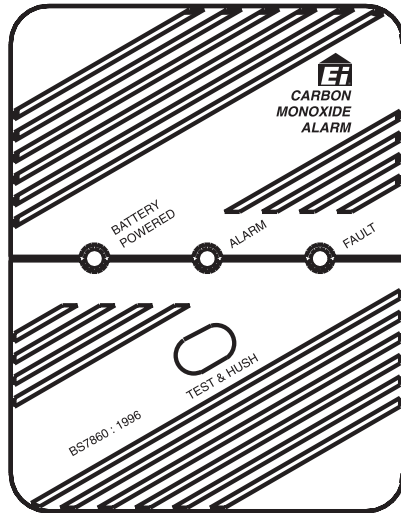

BATTERY POWERED CARBON MONOXIDE ALARM



- Model Ei 204EN** - STANDARD
- Model Ei 205EN** - WITH MEMORY
- Model Ei 205ENA** - WITH MEMORY & SEALED IN BATTERIES
- Model Ei 205CEN** - WITH MEMORY & INTERCONNECT

Read and retain carefully for as long as the product is being used. It contains vital information on the operation and installation. The leaflet should be regarded as part of the product.

If you are just installing the unit, the leaflet must be given to the householder. The leaflet is to be given to any subsequent user.

INSTRUCTIONS

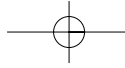

CONTENTS		Page
1	READ THIS FIRST	3
2	WHAT TO DO WHEN THE CO ALARM SOUNDS	4
3	CARBON MONOXIDE - THE SILENT KILLER!	5
4	WHERE TO PLACE CARBON MONOXIDE ALARMS	10
5	INSTALLATION	15
6	TESTING & MONITORING YOUR CO ALARM	19
7	MAINTAINANCE	21
8	LIMITATIONS OF CARBON MONOXIDE ALARMS	22
9	HOW TO PROTECT YOUR FAMILY	24
10	TECHNICAL SPECIFICATIONS	26
11	GETTING YOUR CARBON MONOXIDE ALARMS SERVICED	28
12	GUARANTEES	28
13	TROUBLESHOOTING	30

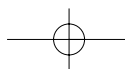

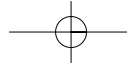



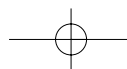

1. READ THIS FIRST

- Power up the unit by smoothly withdrawing the red “pull” tab at the top left hand corner of the unit. If the batteries are supplied separately install the three AA batteries by sliding the upper cover off as shown in figure 5a page 15. The green, red & amber lights will immediately flash in sequence to show they are working - **this is normal**.
- Install the Carbon Monoxide Alarm (CO Alarm) in every room that contains a fuel burning appliance, particularly rooms where people spend a lot of time e.g. bedrooms, kitchens and sitting rooms.
- In rooms with an appliance, install (preferably) on the ceiling, (300mm from walls) and between 1m to 3m horizontally from appliance. In rooms remote from the appliance install at breath level, where the light indicators can be seen.
- Regularly check that the green power light flashes every 45 seconds. If the unit beeps for at least 1 hour when the green light flashes it has reached it's end of life and must be replaced. (If the 'Replace by date' on the side of the unit has not been exceeded replace the batteries if accessible).
- Test the unit weekly by pressing the test/hush button-the horn will sound.
- Replace unit after 5 years operation (see 'Replace by' date on side wall label).



-  When the CO Alarm detects abnormal levels of CO (above 50ppm CO) the **red light** starts to flash immediately and the horn will sound within 90 minutes. At higher levels of CO the alarm will turn on sooner (see table B - page 8).
-  The CO Alarm will automatically reset once the CO has cleared. Pressing the test/hush button resets the CO Alarm immediately (below 300ppm CO). If CO is still present the red light and horn will turn on again after about 4 minutes.
-  The CO Alarm is no substitute for keeping chimneys and flues clear and in good condition, and all of your appliances serviced regularly according to the manufacturer's instructions.
-  Do not fit alarm until all building work is completed to avoid contamination.

2. WHAT TO DO WHEN THE ALARM SOUNDS

- (1) Open the doors and windows to ventilate the area.
- (2) Turn off all fuel appliances where possible and stop using them. (The alarm can be silenced immediately by pushing the test/hush button).
- (3) Evacuate the property leaving the doors and windows open.
- (4) Get medical help immediately for anyone suffering the effects of Carbon Monoxide poisoning (headache, nausea), and advise that Carbon Monoxide poisoning is suspected.

- (5) Ring your gas or other fuel supplier on their emergency number. Keep the number in a prominent place.
- (6) Do not re-enter the property until the alarm has stopped. (If the alarm has been silenced by pressing the test/hush button, wait at least 5 minutes so the alarm can check that the CO has cleared).
- (7) Do not use the fuel appliances again until they have been checked by an expert. In the case of gas appliances this must be a CORGI registered installer.

3. CARBON MONOXIDE - THE SILENT KILLER!

3.1 What is Carbon Monoxide ?

Congratulations on becoming the owner of an Ei Carbon Monoxide Alarm. This will help protect you and your household from the dangerous effects of Carbon Monoxide - the silent killer. (CO is the chemical symbol, indicating the molecule has one carbon atom and one oxygen atom).

Many are killed each year, and many more suffer ill health from Carbon Monoxide (CO) poisoning. CO is an invisible, odourless, tasteless and extremely toxic gas. It is produced by appliances and vehicles burning fuels, such as coal, oil, natural/bottled gas, paraffin, wood, petrol, diesel, charcoal etc. CO is absorbed by red blood cells in the lungs in preference to oxygen - this results in rapid damage to the heart and brain from oxygen starvation.

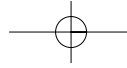

High levels of CO in a house can be caused by:

- Incorrectly or poorly installed fuel-burning appliances.
- Blocked or cracked chimneys/flues.
- Blocked vents or draught-proofing which makes areas with fuel burning appliances or fireplaces airtight.
- Engines of cars, lawnmowers etc. left running in confined spaces.
- Portable paraffin or gas heaters in badly ventilated rooms.

3.2 Symptoms of Carbon Monoxide Poisoning

Most people know that high levels of CO are harmful, however the period of exposure is also important.

The following symptoms are related to Carbon Monoxide poisoning and should be discussed with all members of the household.

Mild Exposure: Slight headache, nausea, vomiting, fatigue (often described as “flu-like” symptoms).

Medium Exposure: Severe throbbing headache, drowsiness, confusion, fast heart rate.

Extreme Exposure: Unconsciousness, convulsions, cardiorespiratory failure, death.

A high level of CO for a short period (e.g. 350 ppm CO for 30 minutes) will cause the same symptoms, a slight headache, as a lower level for a longer time (e.g. 150 ppm for 90 minutes). Table A shows how exposure to different concentrations of CO generally affects people.

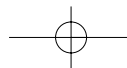

Many cases of reported Carbon Monoxide poisoning indicate that while victims are aware they are not well, they become so disorientated that they are unable to save themselves by either leaving the building or calling for assistance. Young children and household pets may be the first affected.

Table A: Effects of Carbon Monoxide Poisoning

Concentration of CO in Air ▲ ppm	Inhalation Time (approx) and Symptoms Developed
35	The maximum allowable concentration for continuous exposure in any 8 hour period according to OSHA *.
150	Slight headache after 1.5 hours.
200	Slight headache, fatigue, dizziness, nausea after 2-3 hours.
400	Frontal headaches within 1-2 hours, life threatening after 3 hours, also maximum parts per million in flue gas (on an air free basis) according to US Environmental Protection Agency.
800	Dizziness, nausea and convulsions within 45 minutes. Unconsciousness within 2 hours. Death within 2-3 hours.
1,600	Headache, dizziness and nausea within 20 minutes. Death within 1 hour.
3,200	Headache, dizziness and nausea within 5-10 minutes. Death within 25-30 minutes.
6,400	Headache, dizziness and nausea within 1-2 minutes. Death within 10-15 minutes.
12,800	Death within 1-3 minutes.

▲ ppm = parts per million

*OSHA Occupational Safety & Health Association

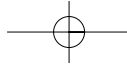

3.3 What happens when your CO Alarm detects Carbon Monoxide ?

When the Alarm detects potentially dangerous levels of CO, it flashes the red alarm light immediately and then sounds a loud alarm if the CO persists. Table B below shows how the CO Alarm reacts to different levels of CO gas and exposure time. At higher levels of CO the alarm turns on sooner. The rate of flashing of the red light indicates the level of CO.

Table B: CO Alarm Response

CO Level ppm	Red Alarm Light	Horn On within
0 ppm	Off *	Off
50ppm	1 Flash / 2 Seconds	60 to 90 minutes
100 ppm	4 Flashes / 2 Seconds	10 to 40 minutes
300 ppm	8 Flashes / 2 Seconds	3 minutes

* unless it has been in alarm (see CO Alarm Memory below)

If your CO Alarm sounds follow the instructions on page 4.

When ventilation is provided by leaving the window and doors open, the CO build up may have dissipated by the time help arrives and the alarm may have stopped sounding. Although your problem may appear temporarily solved it is crucial that the source of the CO is determined and appropriate repairs made.

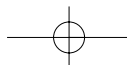

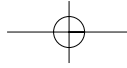

NEVER IGNORE THE ALARM.

Pre-Alarm: When the alarm detects over 50ppm CO the red light flashes every 2 seconds. This helps locate CO leaks as the unit gives an indication straight away. (Without this feature the CO level would need to be at 50ppm CO for 90 minutes for an indication to be given). Note the Pre-Alarm signal may be triggered by CO coming for example, from cooking with gas, from car engines or from nearby barbecues. This is usually not a concern, unless the Pre-Alarm signal persists until the alarm sounds and the CO source is unknown.

NOTE: The CO Alarm may sound if cigarette smoke is blown into it, or aerosols are released nearby.

CO ALARM MEMORY (Ei205EN, Ei205ENA & Ei205CEN only)

- **Red light is Off** – No CO detected since reset or power up.
- **Red light flashes 2 times** (in 2 seconds) every 40 seconds, 50 ppm CO detected for at least about 90 minutes.
- **Red light flashes 4 times** (in 2 seconds) every 40 seconds, 100 ppm CO detected for at least about 40 minutes.
- **Red light flashes 8 times** (in 2 seconds) every 40 seconds, 300 ppm CO detected for at least about 3 minutes.

When the test button is pressed the horn will sound, and the red light will only flash if the unit has previously detected CO and been in alarm. The flash rate indicates the level of CO as in Table B.

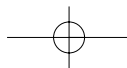

Reset Memory by holding down the test button for over 20 seconds until the red light stops flashing. Cover the horn with a cloth to muffle the alarm during this time.

Please note that the memory will also be reset when the unit is unpowered.

4. WHERE TO PLACE CO ALARMS

4.1 Ideally a Carbon Monoxide Alarm should be installed in:

- Every room containing a fuel burning appliance, and
- Remote rooms where occupants spend a considerable amount of time
- Every bedroom.

However if the number of Carbon Monoxide Alarms is limited, the following points should be considered when deciding where best to fit the alarm(s)

- If there is an appliance in a room where people sleep, place a CO Alarm in this room and
- Locate a CO alarm in a room containing a flueless or open-flued appliance, and
- Locate an alarm in a room where the occupant(s) spend most of their time (e.g. sitting room) and
- In a bedsit, the CO alarm should be placed as far away from the cooking appliance as possible, but near to where the person sleeps and
- If the appliance is in a room not normally used, such as a boiler room, the CO alarm should be placed just outside the room so that the alarm will be heard more easily.

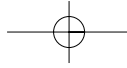

4.2 Unsuitable Locations

Do not place the CO Alarm in any of the following areas.

- (1) In the immediate vicinity of a cooking appliance (keep it at least 1 metre horizontally from it).
- (2) Outside the building.
- (3) In an enclosed space (e.g. in or below a cupboard).
- (4) In a damp or humid area.
- (5) Directly above a sink or cooker.
- (6) Next to a door, window, air vent or anywhere that it would be affected by draughts.
- (7) Next to an extractor fan.
- (8) Where it would be obstructed, e.g. by curtains or furniture.
- (9) In an area where the temperature could drop below -10°C or rise above 40°C .
- (10) Where dirt or dust could block the sensor.
- (11) Where it could be easily knocked or damaged, or where it could be accidentally turned off or removed.
- (12) In a bathroom or other areas where the CO alarm may be exposed to water splashes, dripping or condensation (e.g. above an electric kettle).
- (13) Near paint, thinners, solvent fumes or air fresheners.

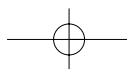
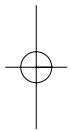

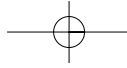

4.31 If locating the CO alarm in a room with a fuel burning appliance (see figure 2)

- If it is mounted on a wall, it should be located at a height greater than the height of any door or window but still be at least 150mm from the ceiling.
- If it is mounted on the ceiling it should be at least 300mm from any wall or light fitting.
- The CO alarm should be a horizontal distance of between 1m and 3m from the potential CO source.
- If there is a partition in the room, the CO alarm should be located on the same side of the partition as the potential source.
- In rooms with sloped ceilings, the CO alarm should be located at the high side of the room (see fig 3).

4.32 If locating the CO alarm in a bedroom or in rooms remote from a fuel burning appliance (see figure 4)

- Mount the CO alarm relatively close to the breathing zone of the occupants.

Whatever position is chosen make sure it is possible to view the three light indicators, when in the vicinity of the alarm.

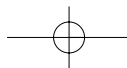

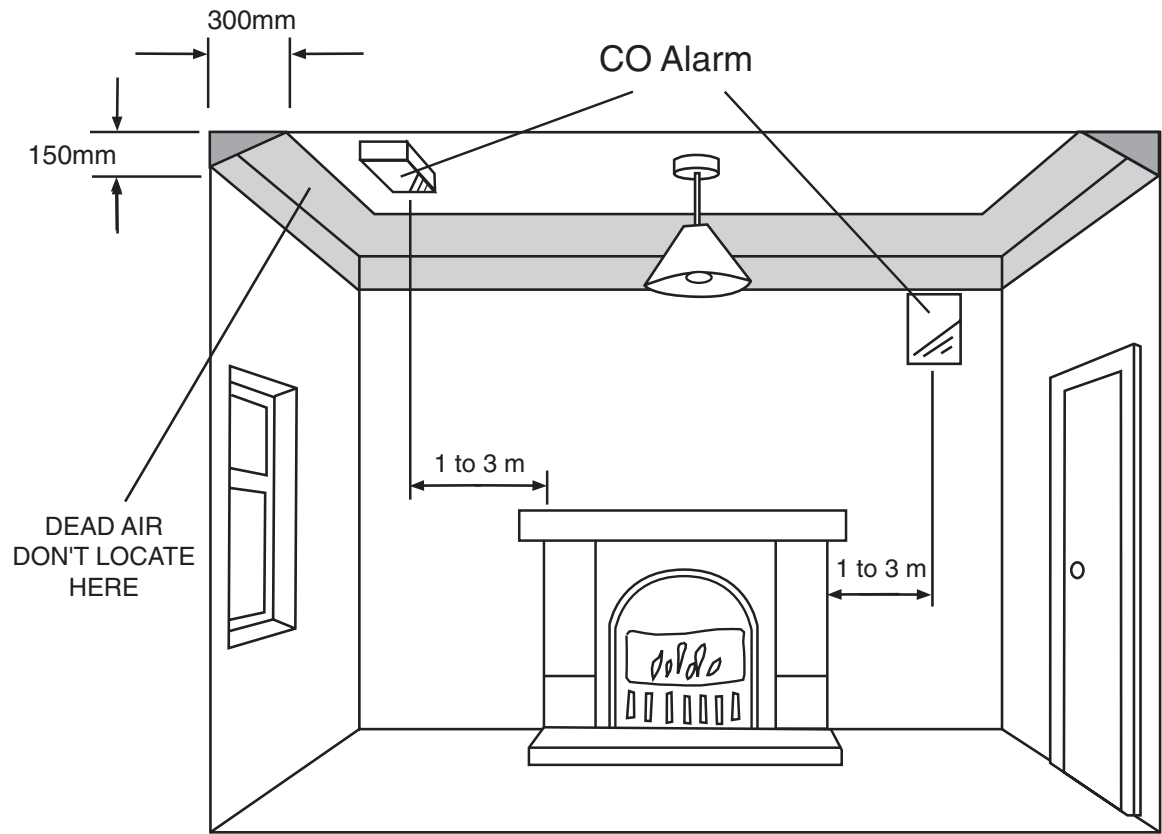

Figure 2.
Location in room with a fuel burning appliance

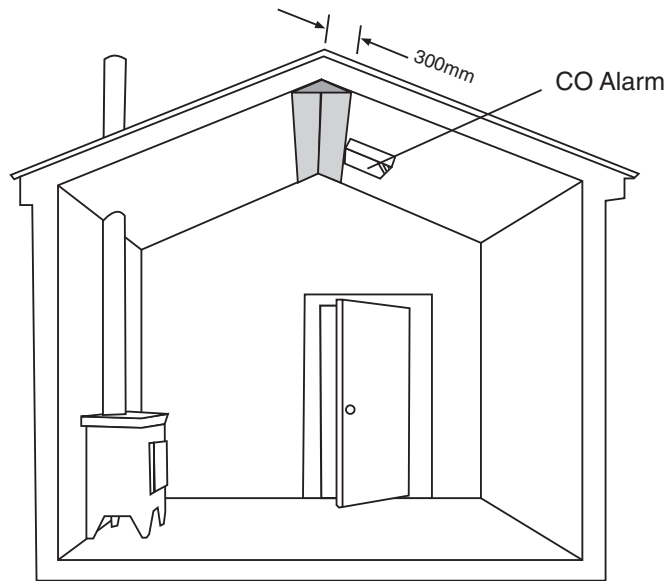

Figure 3. Location in rooms with sloped ceilings, the CO alarm should be located at the high side of the room

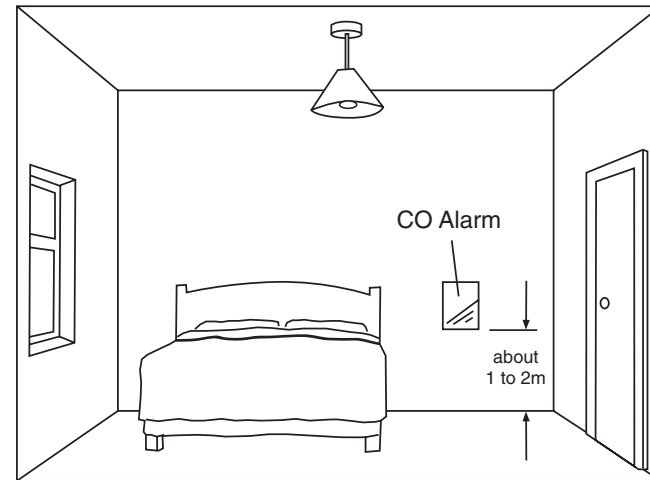

Figure 4. Location in bedrooms & other rooms remote from the appliance (i.e. at breathing level)

5. INSTALLATION

WARNING: Do not use the CO Alarm on an intermittent basis, or as a portable detector for the spillage of combustion products from fuel burning appliances or chimneys.

5.1 INSTALLATION PROCEDURE

Once you have selected a suitable location, power up the unit by smoothly withdrawing the red "PULL" tab at the top left hand corner of the alarm, (see Figure 5b). The green, red & amber lights will immediately flash in sequence to show they are working - this is normal.

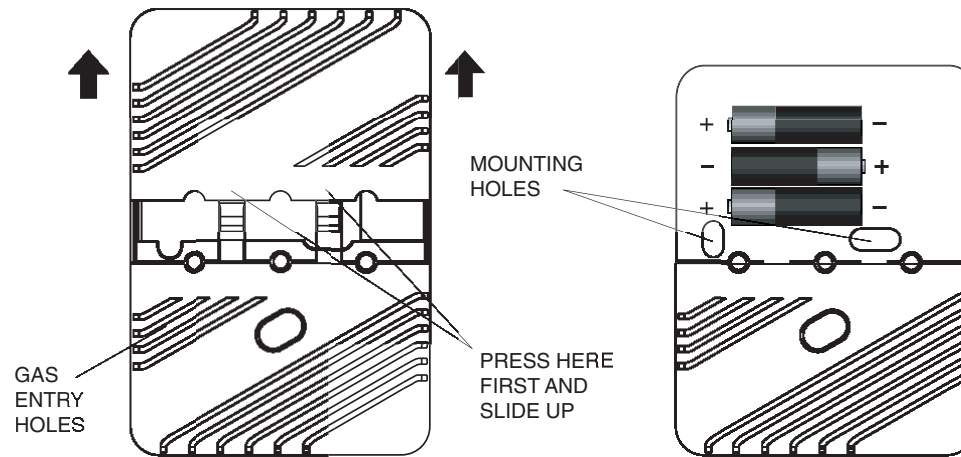

Figure 5a

Once you have selected a suitable location, open the battery compartment by sliding up the cover as shown in figure 5a.

(If the batteries are supplied loose then install the batteries ensuring they are orientated correctly as shown in the battery box. The green, red & amber lights will immediately flash in sequence to show they are working - this is normal).

Mark the position of the two mounting holes by using the unit as a template. Drill two holes using a 6mm drill for the plastic plugs supplied, (ensure you don't drill into the house wiring). Screw the unit to the wall.

Check that the CO Alarm can be heard in all the bedrooms. If not another CO Alarm should be located nearer the bedrooms.

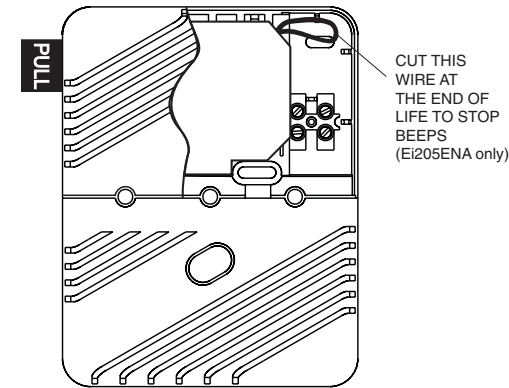

Model: Ei205ENA

Figure 5b

5.2 HOW TO TAMPERPROOF THE ALARM

The battery compartment can be made tamperproof by using the white locking rivet supplied with the screw pack as follows:

- (i) Remove the battery cover as shown in figure 5a.
- (ii) Remove the post shown in figure 6. Place it on the corner of a table and push downwards (note: cover unit with a cloth to prevent the post flying upwards). This should leave a neat circular hole.
- (iii) Put the battery cover back on the unit. Insert the white locking rivet into the hole and push fully home. See figure 7.

The battery compartment cannot now be opened unless the rivet is removed first. This can be removed by inserting a thin screwdriver or blade under the edge and levering it up.

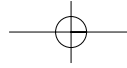

(Note: The Ei205EN, Ei205ENA & Ei205CEN are supplied with 2 locking rivets. Insert the other locking rivet similarly after removing the other post).

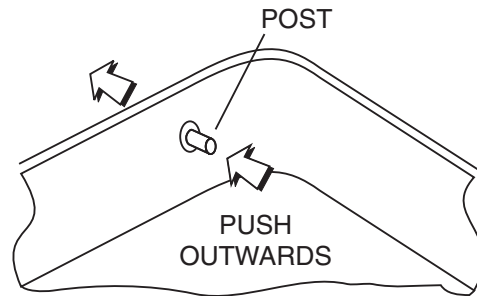

Figure 6

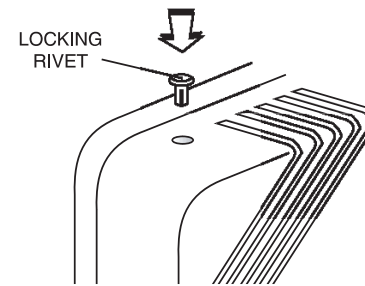
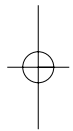

Figure 7



5.3 INTERCONNECTING (Model Ei205CEN only)

Up to 12 Ei 205CEN Carbon Monoxide Alarms can be interconnected so that when one senses CO, all alarm. This helps to ensure that the alarm will be heard throughout the dwelling. Only the unit sensing the toxic gas flashes its red light.

Low polarised cable is suitable, as the alarms are battery powered. Up to 250 metre (820 ft) of wire can be used provided the maximum resistance between any alarm is 50 ohms.

Warning: Do not connect these Ei 205CEN Alarms to any other type of Ei Alarm or to any other model produced by another manufacturer apart from those specified explicitly by Ei Electronics. Doing this may damage the alarms and could result in a shock or fire hazard.

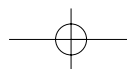

1. Slide off the battery cover as shown in Figure 5a.

2. On the first unit connect twin core cable to the terminals marked 1 and 2 as shown in Figure 8 and bring the cable out through the hole above the terminal block.

3. If they are being surface wired, break one of the three knockouts on the rear side wall. (We do not recommend bringing the wires out the top as cable conduit can prevent the battery box opening).

4. Screw the unit to the wall using the mounting holes.

5. Wire all the rest of the alarms similarly ensuring the terminals marked 1 are all connected together and that the terminals marked 2 are all connected together.

6. After installation press each test button (for at least 15 seconds) in turn and ensure each interconnected unit sounds within 10 seconds. The light (either green or red) will only flash rapidly on the unit with the test button pressed.

These Carbon Monoxide Alarms should only be interconnected within the confines of a single family living unit. If they are connected between different units there may be excessive nuisance alarms - everybody may not be aware when they are being tested.

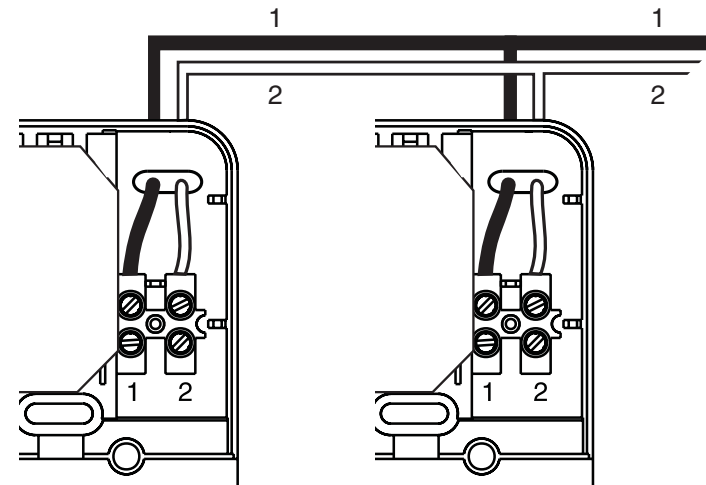
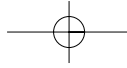

Figure 8



6. TESTING & MONITORING YOUR CO ALARM

Button Test

It is recommended that you test your CO Alarm after installation and then once a week to make sure the unit is working. It will also help you and your family to become familiar with the sound of the alarm.

Press and hold the test button until the alarm sounds (it may take up to 5 seconds) and the green or red light flashes. The alarm will stop sounding shortly after the button is released. If there is a problem follow the checklist below.

Power On Indicator

Regularly check that the green power light flashes every 45 seconds - the unit cannot work without a good battery, properly connected.

Low Battery Indicator

If the unit beeps and the green light flashes simultaneously every 45 seconds, then the three batteries are depleted. Check the 'Replace by' label on the side wall - if it has been exceeded replace the entire unit. If it has not be exceeded and the batteries are accessible (after the battery door is removed - see figure 5a page 15) replace the batteries. Use only the following Alkaline AA size batteries: Duracell MN1500, Panasonic LR6, GP 15A, Ever Ready LR6 or Energizer E91. (See section 5.2 - page 16, if the locking rivet(s) has been inserted). Insert the new batteries with the orientation shown on the base. Button test the alarm to check the batteries are installed correctly and that they are not depleted. Slide back on the cover.

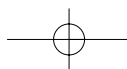

(The batteries will usually last over 4 years in standby under normal conditions. An undepleted battery can power a unit in alarm for over 100 hours. The life will be reduced if the unit regularly goes into alarm or if it is exposed to excessive temperatures for long periods).

Amber Fault Indicator

If the unit beeps and the amber light flashes simultaneously every 45 seconds the self-checking circuitry may have detected a fault. Follow the checklist to see if the unit is actually defective.

Checklist in the event of problems

Check the 'pull' tag has been removed to connect the batteries.

Check there are three batteries installed with the correct orientation in the battery compartment. (If the batteries are accessible remove one battery for 1 minute to reset the microcontroller in the unit).

If the problem persists replace the batteries if they are accessible.

If none of the above solve the problem the unit is probably defective and must be replaced. See "Getting the CO Alarm Serviced Page 28)".

Testing with Carbon Monoxide

The unit can be tested with CO by using one of the kits that comes with CO either in a glass phial or aerosol can. Follow the instructions on the kit. It is best if possible to inject the CO gas into the gas entry holes, see Figure 5a. When it senses the CO, it flashes the red light (as per Table B) to confirm that is detecting CO gas.

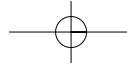

How to distinguish between CO Alarm and Smoke Alarm warnings

The CO Alarm has a distinctive on-off sound of 3 pulses, followed by a pause as compared with a typical Smoke Alarm which has a rapid pulsing sound.

In addition, when your CO Alarm detects CO the red light will be flashing.

Testing both your CO Alarm and Smoke Alarms weekly will help you and your family to clearly distinguish between them in an emergency.

7. MAINTAINENCE

Clean the outside case by occasionally wiping with a clean damp cloth. Do not use any cleaning agents, bleaches, detergents or polishes, including those in aerosol cans. Avoid spraying air fresheners, hair spray, paint or other aerosols near the CO Alarm. Do not place air fresheners near the unit.

Use the narrow nozzle of a vacuum cleaner to remove fluff and other contamination from the cover slots to ensure CO gas can reach the sensor - see Gas Sensor positioning shown in figure 5a.

Caution: Do not paint the CO Alarm.

Remove the CO Alarm when decorating. Do not allow water or dust to contaminate the alarm.

Warning: Do not open or tamper with the CO Alarm. There are no user serviceable parts inside This can damage the unit.

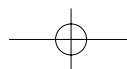

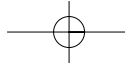

End of Life

When the unit has completed up to 6 years of operation the amber light will flash every 40 seconds. The entire unit must then be replaced.

It must also be replaced when the date on the “Replace Unit by” label on the side wall is exceeded.

When the battery is depleted the unit will beep every 45 seconds when the green light flashes. The beeps on an Ei205EN or Ei205CEN CO Alarm only may be silenced by cutting the wire situated under the cover. See figures 5a & 5b to see how to remove the cover and locate the wire. On other units first remove the battery cells.

Product Disposal

The crossed out wheellie bin symbol on the product means that it should not be put into household waste. Please recycle where facilities exist. Check with your local authority or retailer for recycling advice.



The date code on the product indicates when the product was manufactured e.g. 05W40 means week 40 in the year 2005.

8. LIMITATIONS OF CO ALARMS

(1) The CO Alarm will not work without good batteries - the green power light must flash every 45 seconds. If the battery has been drained the alarm will not give protection. Button test the alarm on return from holidays and other long absences.

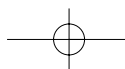

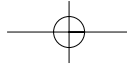

(2) Carbon Monoxide must enter the unit for it to be detected. There may be Carbon Monoxide in other areas of the house (e.g. downstairs, in a closed room etc). but not in the vicinity of the CO Alarm. Doors, air draughts and obstructions can prevent the CO reaching the Alarm. For these reasons we recommend. CO Alarms are fitted both near and in bedrooms, particularly if bedroom doors are closed at night. Additionally install in rooms where members of the household spend much of their time, and in rooms with potential sources of CO gas.

(3) The CO Alarm may not be heard. The sound output is loud but it may not be heard behind a closed door or if it is too far away. Interconnecting CO Alarms greatly improves the probability that they will be heard. The Alarm may not wake up somebody who has taken alcohol or drugs. The alarm sound may be masked by other sounds such as T.V., stereo, traffic noise etc. Fitting CO Alarms on either side of closed doors will improve their chance of being heard. This CO Alarm is not designed for people with impaired hearing.

(4) CO Alarms don't last indefinitely. CO Alarms are sophisticated electronic devices with many parts. Although the alarm and its component parts have undergone stringent tests, and are designed to be very reliable, it is possible that parts can fail. Therefore, you should test your CO Alarm weekly. The CO Alarm must be replaced after 5 years operation.

(5) CO Alarms are not a substitute for life insurance. House-holders are responsible for their own insurance. The CO Alarm warns of increasing CO levels, but we do not guarantee that this will protect everyone from CO poisoning.

(6) CO Alarms are not suitable as early warning Smoke Alarms. Some fires produce

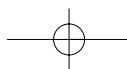

Carbon Monoxide, but the response characteristics of these CO Alarms are such that they would not give sufficient warning of fire. Smoke Alarms must be fitted to give early warning of fire.

The CO Alarm does not detect the presence of natural gas (methane), bottled gas (propane, butane) or other combustible gases. Fit combustion gas alarms to detect these.

WARNING: THIS CO ALARM IS DESIGNED TO PROTECT INDIVIDUALS FROM THE ACUTE EFFECTS OF CARBON MONOXIDE EXPOSURE. IT WILL NOT FULLY SAFEGUARD INDIVIDUALS WITH SPECIFIC MEDICAL CONDITIONS. IF IN DOUBT CONSULT A MEDICAL PRACTITIONER.

9. HOW TO PROTECT YOUR FAMILY

Follow these guidelines to reduce the risk of Carbon Monoxide poisoning.

- (1) Know and look out for tell-tale signs that Carbon Monoxide may be present. These include:-
 - The CO Alarm warning of abnormal levels.
 - Staining, sooting or discolouration on or around appliances.
 - A pilot light frequently going out.
 - A strange smell when an appliance is working.
 - A naked gas flame which is yellow or orange, instead of the normal blue.
 - Family members (including pets) exhibiting the “flu-like” symptoms of CO poisoning described above.

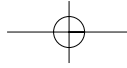

If any of these signs are present get the appliance checked out by an expert before further use. If family members are ill get medical help.

- (2)** Choose all appliances and vehicles which burn fossil fuels such as coal, oil, natural/bottled gas, paraffin, wood, petrol, diesel, charcoal etc. with care and have them professionally installed and regularly maintained.
- (3)** These appliances must “breathe in” air to burn the fuel properly. Know where the air comes from and ensure vents/air bricks etc. remain unobstructed (particularly after building work).
- (4)** The appliances must also “breathe out” the waste gases (including the CO) – usually through a flue or chimney. Ensure chimneys and flues are not blocked or leaking, and get them checked every year. Check for excessive rust or cracks on appliances and pipe work.
- (5)** Never leave your car, motor bike or lawnmower engine running in the garage with the garage door closed. Never leave the door from the house to the garage open if the car is running.
- (6)** Never adjust your own gas pilot lights.
- (7)** Never use a gas cooker or a barbecue for home heating.
- (8)** Children should be warned of the dangers of CO poisoning and instructed never to touch, or interfere with the CO Alarm. Do not allow small children to press the test/hush button as they could be subjected to excessive noise when the unit alarms.

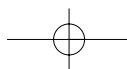
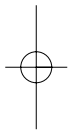

- (9) Leaving windows or doors slightly open (even a few inches) will significantly reduce the risk of high levels of CO occurring. The high levels of draught-proofing in modern houses reduces ventilation and can allow dangerous gases to build up.
- (10) Install CO Alarms in all the areas recommended in this leaflet.
- (11) Recognise that CO poisoning may be the cause when family members suffer from “flu-like” symptoms when at home but feel better when they are away for extended periods.

10. TECHNICAL SPECIFICATION

Power	: Three Alkaline AA type batteries (supplied)
CO Sensitivity	: Meets BS EN 50291: 2001. Unit operates as per Table B (on page 8).
Electromagnetic Compatibility	: Complies with BS EN 50270
Test/Hush Button	: Checks electronics and horn.

When the unit is alarming, after sensing CO, pressing the test/hush button will immediately stop the horn (the red light will continue to flash). If CO is still present the red light and the horn will turn on again after about 4 minutes. The unit can only be silenced once during a CO incident. At 300 ppm CO the unit cannot be silenced. (With interconnected units, the hush only works on the alarm sensing CO).

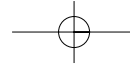

- Testing with CO : The red light flashes (as per Table B) within 10 seconds of unit detecting CO.
- Initialisation Time : 70 seconds. On power up red and amber lights flash momentarily to show they are operational.
- Operating Temperature : -10°C to 40°C
- Humidity Range : 15% to 95% R.H. (non-condensing)
- Audible Alarm : 85dB(A) at 3m minimum
- Self Diagnostics : Horn beep and amber fault light flashes every 40 seconds if a sensor fault is found.
- Tamperproof : Locking Rivet(s) supplied.
- Interconnect (Ei205CEN only) : Up to 12, Ei205CEN Alarms can be interconnected, so that when one senses CO, all alarm.
- CO Alarm Memory: (Ei205EN & Ei205CEN only) : A unit will indicate if it has been in alarm previously by flashing the red light for 2 seconds every 40 seconds (2 flashes for 50 ppm CO, 4 flashes for 100 ppm CO and 8 flashes, for 300 ppm CO). When the test button is pressed the red light flashes as per table B and also indicates the previous CO alarm level detected. The memory is cleared by holding down the test button until the red light stops flashing.

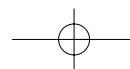
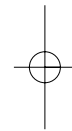
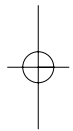

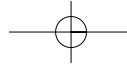

End of Life Indication: Amber light flashes every 45 seconds after 6 years to show the unit must be replaced.

Dimensions : 135 x 105 x 71 mm.

Weight : 260g.

11. GETTING THE CO ALARM SERVICED

If your CO Alarm fails to work after you have carefully read all the instructions, checked the unit has been installed correctly, and ensured that it has good batteries connected ('pull' tag should be removed), return it for repair or replacement. This should be where it was purchased, or alternatively return it in a padded box to "Customer Assistance and Information" at the nearest address given on the CO Alarm or in this leaflet. (If the unit is beeping then remove the battery if replaceable or cut the end of life wire on the Ei205A shown in figure 5b - page 16). State the nature of the fault, where the CO Alarm was purchased, and the date of purchase.

12. GUARANTEES

Ei Electronics guarantees Carbon Monoxide Alarms Models Ei204EN & Ei205EN (excluding replaceable batteries) for two years from date of purchase against any defects that are due to faulty materials or workmanship.

Ei Electronics guarantees Carbon Monoxide Alarms Models Ei205ENA & Ei205CEN (excluding batteries) for five years from date of purchase against any defects that are due to faulty materials or workmanship.

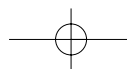

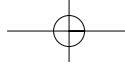

These guarantees only apply to normal conditions of use and service, and do not include damage resulting from accident, neglect, misuse, unauthorised dismantling, or contamination howsoever caused. These guarantees exclude incidental and consequential damage. If the Carbon Monoxide Alarm should become defective within the guarantee period, it must be returned to where it was purchased or alternatively to Ei Electronics, carefully packaged, with the problem clearly stated (see section 11 “Getting the CO Alarm Serviced”) along with proof of the date of purchase. We shall at our discretion repair or replace the faulty unit.

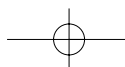
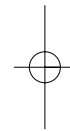
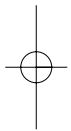

13. TROUBLESHOOTING

ALARM DOES NOT WORK WITH THE TEST BUTTON:

- (1) Hold button down firmly for at least 5 seconds.
- (2) Check the 'pull' tag is removed and/or the batteries are correctly connected.
- (3) Replace batteries (if they are accessible).

ALARM BEEPS EVERY 45 SECONDS:

If the Alarm beeps every 45 seconds and **green light flashes at the same time**, then the unit must be replaced if the 'Replace by' date on the side wall has been exceeded. If it is not exceeded, and the batteries are accessible, replace the batteries.

If the Alarm beeps every 45 seconds and **amber light flashes at the same time**, then the unit is probably defective. If the batteries are accessible, disconnect batteries and/or press the test button. If problem persists, replace the unit.

ALARM SOUNDS FOR NO APPARENT REASON:

Follow the detailed instructions in section 2. entitled "What to do when the alarm sounds" (page 4).

If there is still problems:

- (1) Ensure there are no fuel burning appliances in the vicinity which could be leaking CO gas (e.g. even from next door).

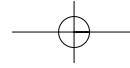

(2) Ensure there are no fumes in the area (e.g. paint, thinners, hair spray, chemical cleaners aerosol sprays etc).

(3) Ensure there is no outdoor source of CO in the vicinity (e.g. a car with engine running, heavy traffic, heavy air pollution, barbecue fumes etc).

(4) Press the test/hush button to silence the alarm.

If the unit continues to sound it is possibly defective and should be replaced (see section 11 “Getting the CO Alarm Serviced”).

ALL LIGHTS FLASH:

On power up the green, red and amber lights turn on in sequence to show they are working. **THIS IS NORMAL.**

AMBER LIGHT FLASHING (every 45 seconds):

The unit has been operating for 6 years and must be replaced.

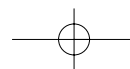

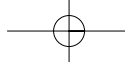

Ei Electronics

Shannon, Co. Clare, Ireland.

Tel: (061) 471277 Fax: (061) 471053

E-mail. helpdesk@eilttd.ie

www.eielectronics.com

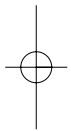

Aico Ltd.

Mile End Business Park, Maesbury Rd, Oswestry,
Shropshire, SY10 8NN,

U.K. Tel: 0870 7584000 Fax: 0870 7584010

E-mail: support@aico.co.uk

www.aico.co.uk

